

## Ecophon Wall Panel C

Horizontal installation 2700x600

M196

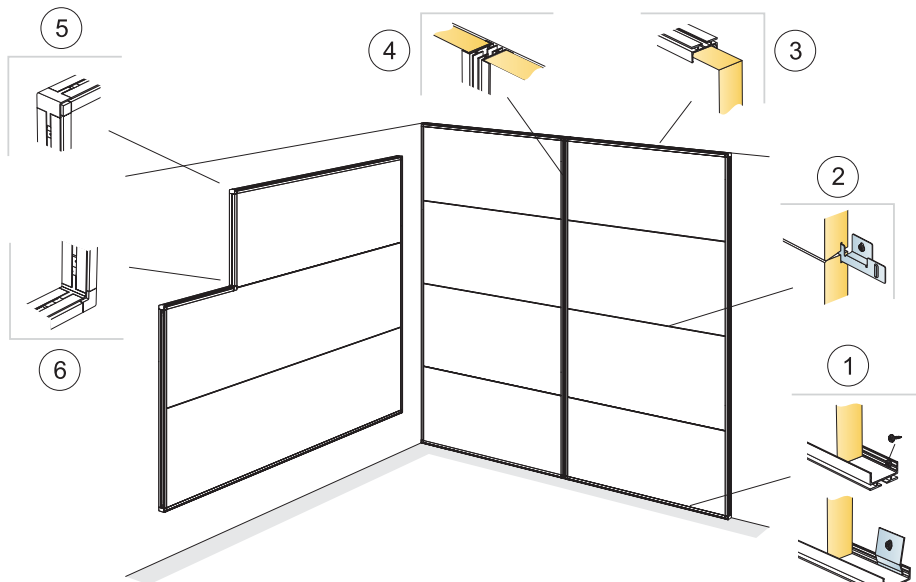

1. Connect WP Profile L=2687 mm, fixed (alt. with Connect Fixing bracket 0214) at 400 mm centres.



2. Horizontal joint between panels: Connect Fixing plate 0299 is mounted at 500 mm centres.

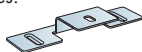

3. Connect WP Profile L=2687, fixed at 400 mm centres.



4. Vertical joint between panels: Connect WP Profile L=2687, fixed at 400 mm centres.



5. Connect WP External corner mounted in Connect WP Profile L=2687.

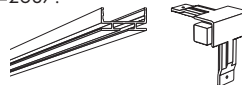

6. Connect WP Internal corner mounted in Connect WP Profile L=2687.

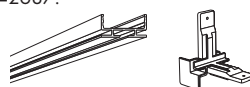



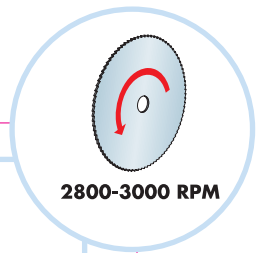
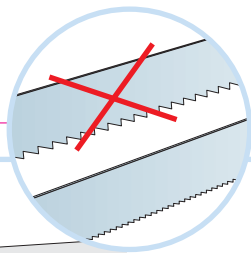
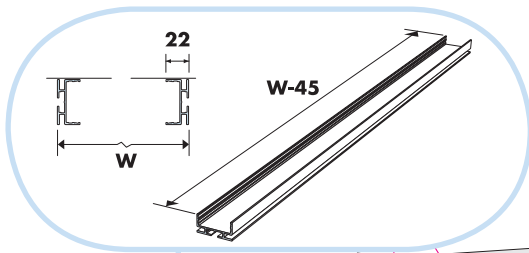

1

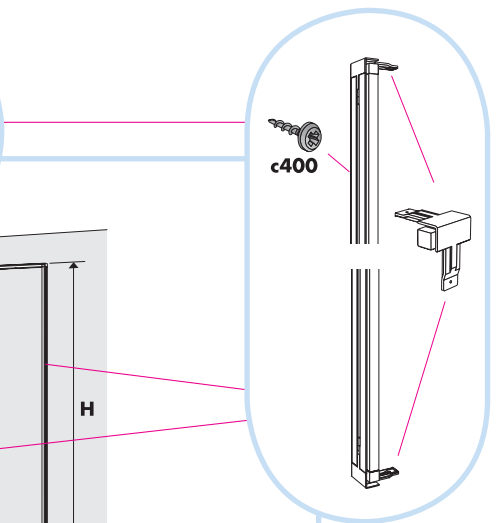
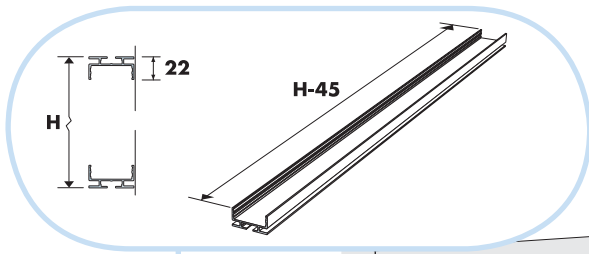
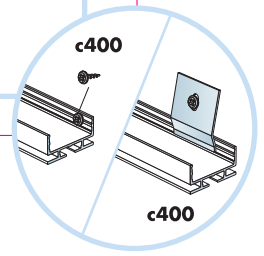
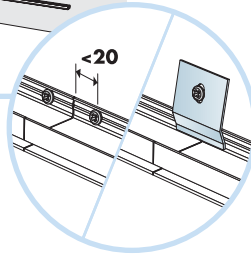
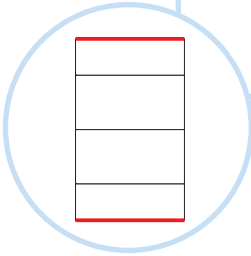
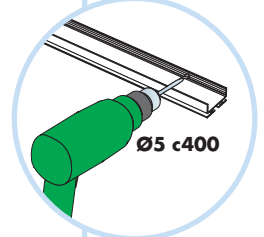
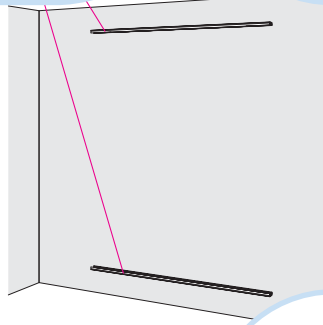

2

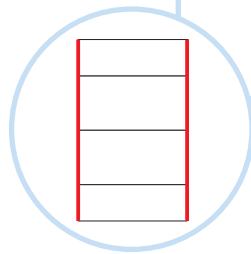
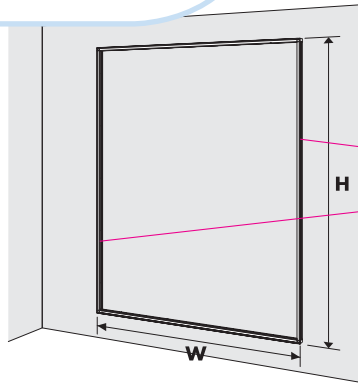

3

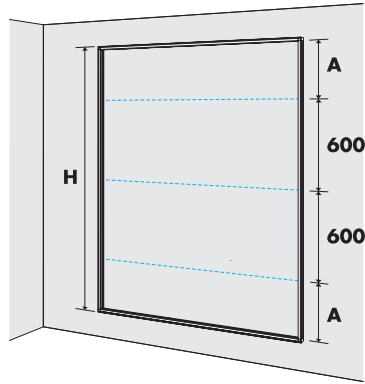

$$H=2 \times 16+2A+n \times 600$$

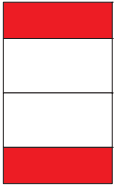
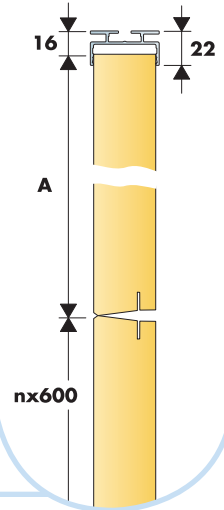

4

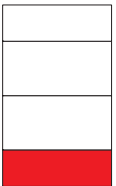
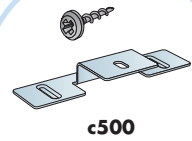
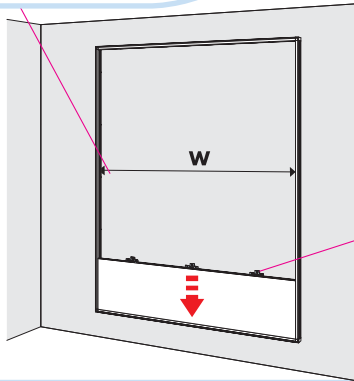
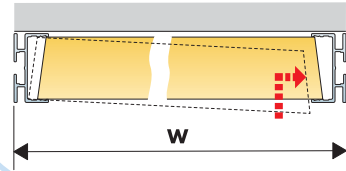
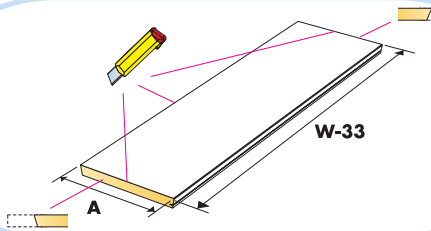

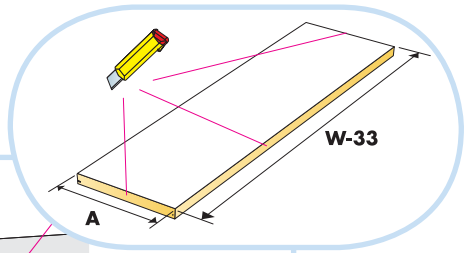
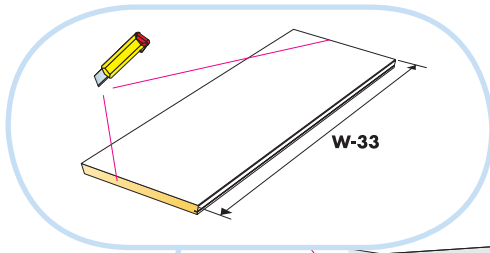

5

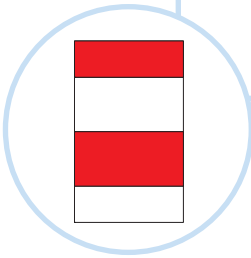
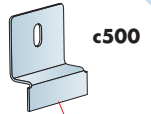
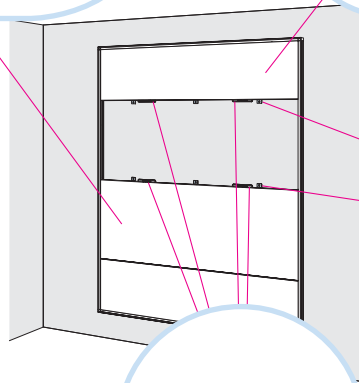

2630-0219

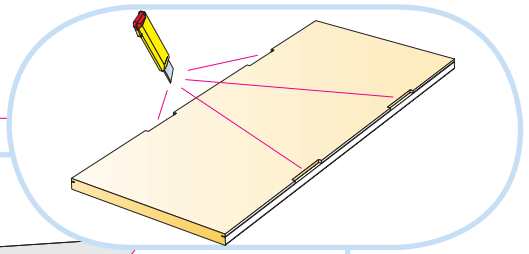
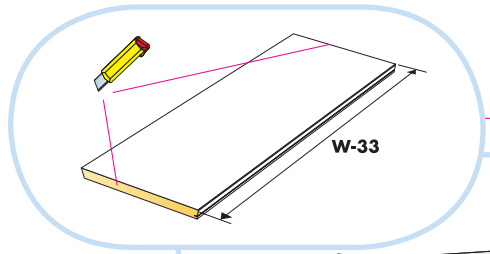

6

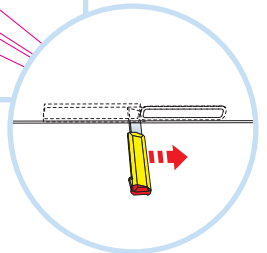
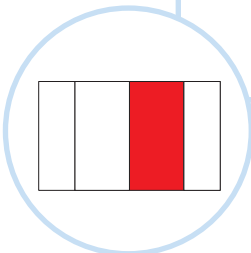
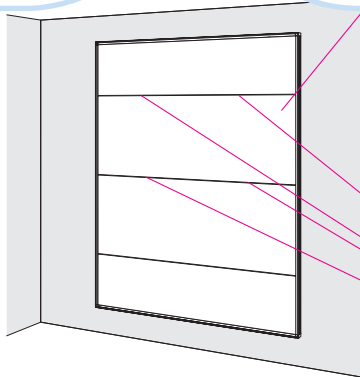

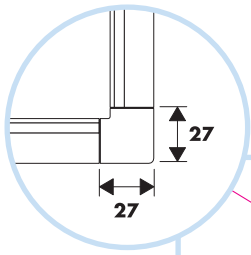

7

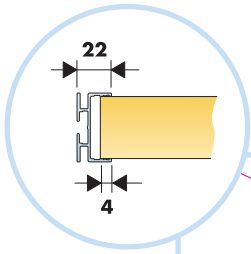
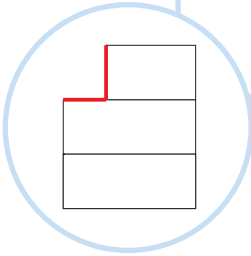
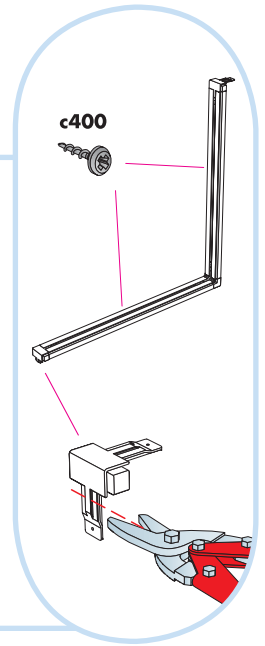
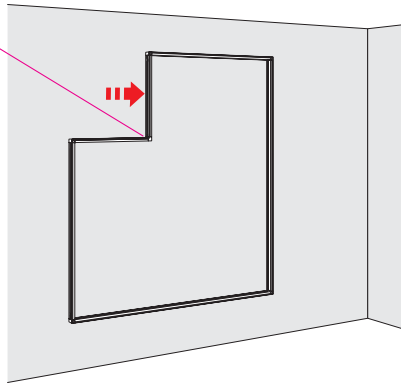

8

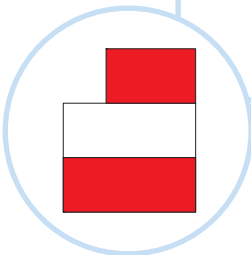
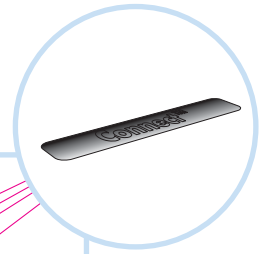
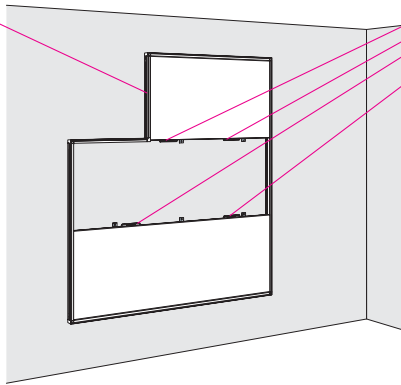

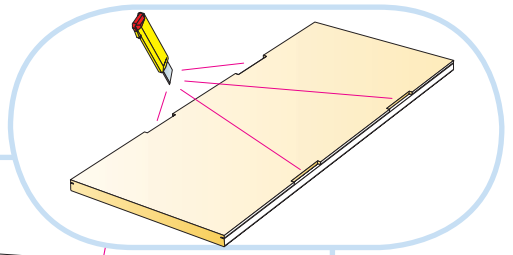
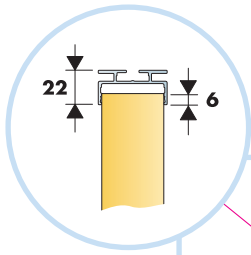

9

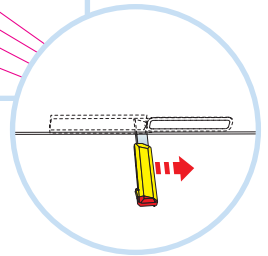
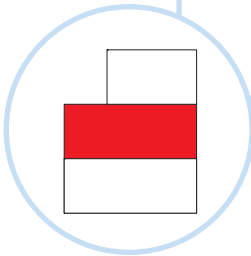
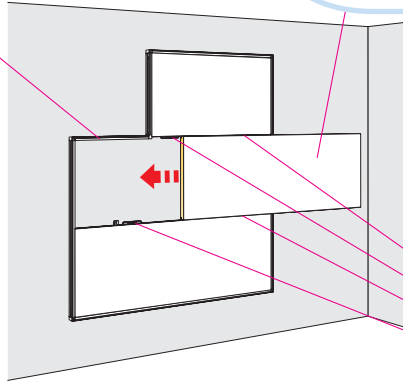

10

